

## Quick installation guide

Conveyor system  
MB-flex S aluminium

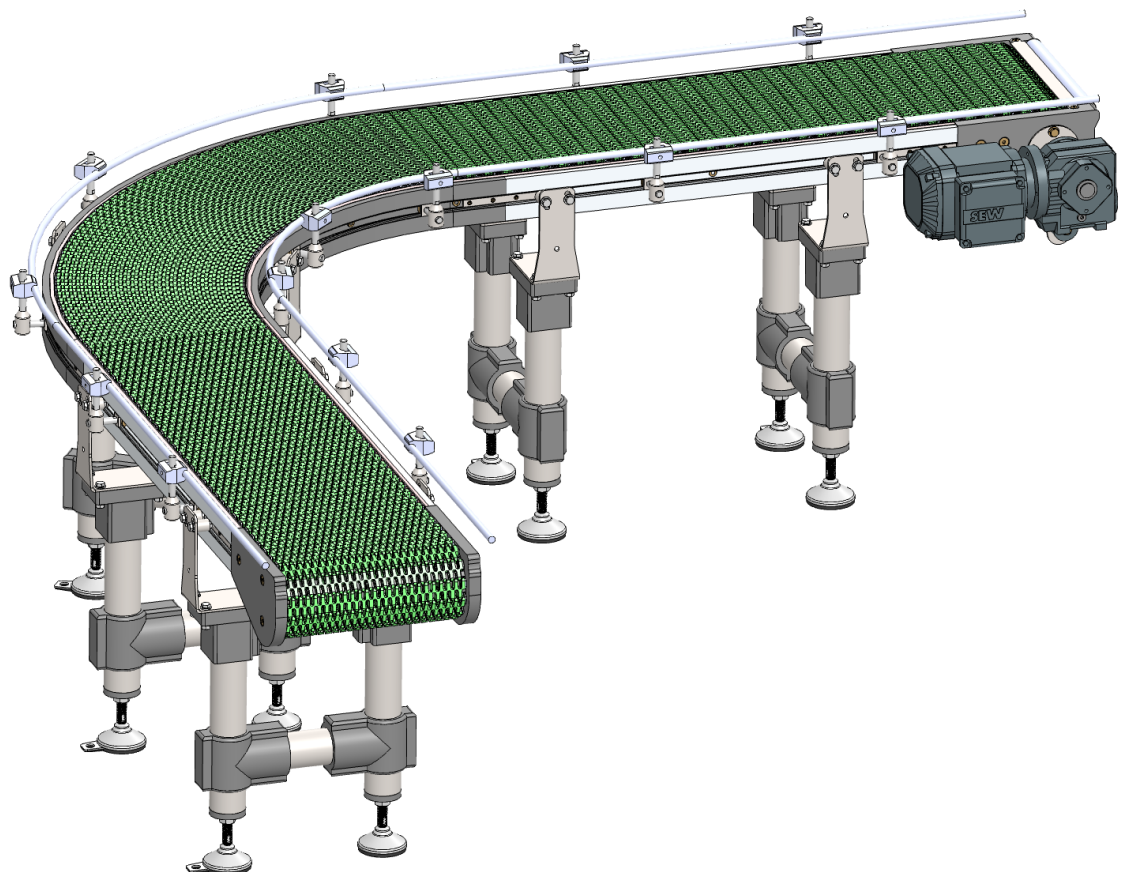

**Conveyor system** MB-flex S aluminium

**Publisher** euroflex GmbH  
Hohe-Flum-Strasse 62  
79650 Schopfheim  
Germany  
Tel: + 49 (0) 07622 68 453-30  
Fax: + 49 (0) 07622 68 453-01  
E-Mail: [info@euroflexgmbh.de](mailto:info@euroflexgmbh.de)  
Internet: [www.euroflexgmbh.de](http://www.euroflexgmbh.de)

The document is protected by copyright. All rights are strictly reserved. Copying, reproduction, translation or conversion to an electronic medium or machine-readable form as an entire document or in parts is prohibited without approval of euroflex GmbH.

Subject to modification.

**Suggestions and comments** ... regarding this documentation or the system are to be sent to the address above.

**Last modification** 19.04.2023

# Content

<b>1</b>	<b>Reader information .....</b>	<b>4</b>
1.1	Target group .....	4
1.2	Customer service .....	4
1.3	Copyright protection .....	4
<b>2</b>	<b>Safety .....</b>	<b>5</b>
2.1	Owner.....	5
2.2	Obligations of the owner .....	5
2.3	Instruction of the personnel .....	6
2.4	Qualification requirements .....	6
2.4.1	Specially trained personnel.....	6
2.4.2	Operating personnel .....	6
2.4.3	Maintenance personnel.....	6
2.4.4	Qualified specialist personnel .....	6
2.4.5	Electricians.....	7
2.4.6	Specialist pneumatic personnel .....	7
2.4.7	Specialist hydraulic personnel .....	7
2.5	Personal protective equipment .....	7
2.6	Protective enclosure/Protective cover .....	7
2.7	Spare parts and their purchase .....	8
<b>3</b>	<b>Assembly .....</b>	<b>9</b>
3.1	Overview of MB-flex S aluminium.....	9
3.2	Assembly the slide rails and slide profiles on the modular belt conveyor .....	10
3.2.1	Assembly the slide rails on the modular belt conveyor.....	11
3.2.2	Assembly the slide profiles on the modular belt conveyor.....	13
3.3	Assembling the modular chain belt.....	15
<b>4</b>	<b>Cleaning .....</b>	<b>17</b>
4.1	Personnel and Protective equipment.....	17
4.2	Selection of the cleaning agent.....	17
4.3	Preparation .....	18
4.4	Execution .....	18
<b>5</b>	<b>Maintenance .....</b>	<b>20</b>
5.1	Lubrication .....	20
5.2	Maintenance plan.....	21
5.3	Maintenance log.....	23
5.4	Repair .....	23
5.4.1	Conveyor chain: Repair or adjust the chain tension .....	24
<b>6</b>	<b>Table of figures .....</b>	<b>27</b>

# 1 Reader information

---

This chapter provides information on the usage of the installation guide:

- Target group (Page 4)
- Customer service (Page 4)
- Copyright protection (Page 4)

## 1.1 Target group

This installation guide is intended for the owner, operators and the service personnel.



### Info

---

The relevant personnel must have specific qualifications in order to work on or with the system. The personnel qualification can be found in the section „Qualification requirements“ (Page 6).

---

## 1.2 Customer service

Our customer service department will be happy to advise you on technical matters. Information on ordering spare parts can be found in the section “Spare parts and their purchase” (Page 8).

### Customer service

Designation	Specification
Company	euroflex GmbH
Street no.	Hohe-Flum-Straße 62
Postcode, place	79650 Schopfheim
Country	Germany
Telephone	+49 (0) 7622/68453-30
Fax	+49 (0) 7622/68453-01
Email	info@euroflexgmbh.de

## 1.3 Copyright protection

This installation guide is protected by copyright.

The unauthorized forwarding of the installation guide to third parties, reproduction in any type and form, including extracts, as well as the utilization and/or communication of the content are not permitted without the written approval of the manufacturer.

Infringement will lead to compensation for damages. Rights reserved for further claims.

## **2 Safety**

---

This chapter provides information on the safe operation of the conveyor system:

- Owner (Page 5)
- Obligations of the owner (Page 5)
- Instruction of the personnel (Page 6)
- Qualification requirements (Page 6)
- Personal protective equipment (Page 7)
- Protective enclosure/Protective cover (Page 7)
- Spare parts and their purchase (Page 8)

### **2.1 Owner**

The owner is every natural and legal person that uses the conveyor system or permits it to be used by third parties, and who is also responsible for the safety of the user, personnel or third party during usage.

The owner is responsible for the correct assembly and accident-free operation of the system, in accordance with the Machinery Directive 2006/42/EC.

For all work on the conveyor system, the safety regulations resulting from the specifications of the Machinery Directive 2006/42/EC must be implemented and complied with.

### **2.2 Obligations of the owner**

The owner is obliged to implement measures that result from the specifications provided by the Machinery Directive 2006/42/EC.

The safety, accident prevention and environmental protection regulations valid for the conveyor system's area of application must be complied with.

The owner is obliged to do the following in particular:

- Provide information regarding the applicable occupational safety provisions and, via a risk assessment, determine additional dangers that may result due to the special working conditions at the conveyor system's deployment site. He must implement this in the form of operating instructions for the operation of the conveyor system.
- Regularly check the operating instructions and ensure that they correspond to the current status of the regulations.
- Instruct the utilized personnel on possible dangers and the corresponding protective measures. These instructions should be repeated at appropriate intervals.
- Instruct the utilized personnel on handling the conveyor system.
- Equip the utilized personnel with the required protective equipment and check that it is worn at all times.

## 2.3 Instruction of the personnel

Each person assigned to carry out work must, before commencing, receive instruction from the owner regarding their delegated activities and potential dangers during work.

For instruction, observe the following:

- Repeat instruction at regular intervals.
- Verifiably log each personnel instruction session.

## 2.4 Qualification requirements

Safety note: Risk of injury due to insufficient qualification.

If the conveyor system is used improperly, property damage may occur, or persons may be injured or killed.

- » All activities may only be carried out by personnel who have the required training, understanding regarding the functioning of the conveyor system and the relevant experience.

Furthermore, special qualifications are required for certain tasks. These are defined as follows.

### 2.4.1 Specially trained personnel

Specially trained personnel are persons who have been instructed on the tasks delegated to them and their potential dangers by the owner.

### 2.4.2 Operating personnel

Operating personnel are persons who have been instructed on the tasks delegated to them and their potential dangers by the owner. The operating personnel are capable of operating the conveyor system independently. The operating personnel have been instructed regarding possible dangers in the event of improper behaviour. Cleaning and control tasks on the conveyor system are carried out independently.

### 2.4.3 Maintenance personnel

Maintenance personnel are persons who, as a result of their technical training (e. g. mechanical, electrical, pneumatic), knowledge, experience and awareness of pertinent norms and provisions, are capable of correctly carrying out their delegated tasks. Maintenance personnel are capable of recognizing potential dangers independently, and consequently avoiding them.

### 2.4.4 Qualified specialist personnel

Qualified specialist personnel are persons who have obtained and proven special experience, knowledge and skills for the safe performance of tasks in particular specialist areas (e. g. mechanical, pneumatic, hydraulic, electrical) and who fulfil the following defined requirements.

### **2.4.5 Electricians**

Electricians are persons who, as a result of their technical training, knowledge, experience and awareness of pertinent norms and provisions, are capable of correctly carrying out work on electrical systems. Electricians are capable of recognizing potential dangers independently, and consequently avoiding personal injury and property damage caused by electrical currents.

All work on the electrical equipment may only be carried out by electricians.

### **2.4.6 Specialist pneumatic personnel**

Specialist pneumatic personnel are persons who, as a result of their technical training, knowledge, experience and awareness of pertinent norms and provisions, are capable of correctly carrying out work on pneumatic systems. Specialist pneumatics personnel are capable of recognizing potential dangers independently, and consequently avoiding personal injury and property damage caused by pneumatic systems.

All work on pneumatic equipment may only be carried out by specialist pneumatic personnel.

### **2.4.7 Specialist hydraulic personnel**

Specialist hydraulic personnel are persons who, as a result of their technical training, knowledge, experience and awareness of pertinent norms and provisions, are capable of correctly carrying out work on hydraulic systems. Specialist hydraulic personnel are capable of recognizing potential dangers independently, and consequently avoiding personal injury and property damage caused by hydraulic systems.

All work on hydraulic equipment may only be carried out by specialist hydraulic personnel.

## **2.5 Personal protective equipment**

Wearing personal protective equipment is an important element of safety. Missing or unsuitable personal protective equipment increases the risk of health damage and personal injury.

## **2.6 Protective enclosure/Protective cover**

The conveyor system must be equipped with a protective enclosure/cover in areas where there is a danger to persons. The protective enclosure/cover protects the operator and other persons from injuries caused by danger points inside the enclosure/cover.

The owner is responsible for equipping the system with a protective enclosure/cover.

## 2.7 Spare parts and their purchase

Spare parts and accessories can be ordered directly from the manufacturer via the following contact.

### Spare parts: Contact

Designation	Specification
Company	euroflex GmbH
Street no.	Hohe-Flum-Straße 62
Postcode, place	79650 Schopfheim
Country	Germany
Telephone	+49 (0) 7622/68453-00
Fax	+49 (0) 7622/68453-01
Email	info@euroflexgmbh.de



## 3 Assembly

This chapter provides information on the assembly of the conveyor system:

- Overview of MB-flex S aluminium (Page 9)
- Assembly the slide rails and slide profiles on the modular belt conveyor (Page 10)
- Assembling the modular chain belt (Page 15)

### 3.1 Overview of MB-flex S aluminium

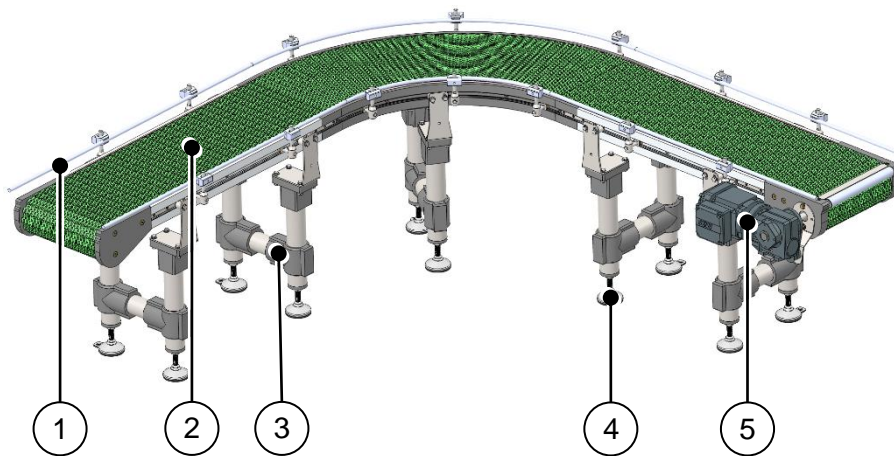

Fig. 1: Overview of MB-flex S aluminium (example)

#### Legend

No.	Designation
1	Side guide
2	Modular chain belt
3	Support
4	Base plate
5	Motor

#### Information

Data	Designation or value
Personnel	Maintenance personnel
Personal protective equipment	Protective work clothing Protective gloves Safety shoes
Tools, aids	Mitre cutter Steel pin (Ø 4 mm x approx. 200 mm long) Hammer Carpet knife Assembly tool Drill and drill bit Ø 3.4 mm



## WARNING

### Risk of injury and serious damage to property due to improper installation!

A lack of knowledge about the system and experience in assessing and averting residual risks during proper assembly can result in injury and even death.

- » Before working on the system, turn it off and guard it from being switched back on.
- » Prior to working in the system area, empty or clear the system.
- » Regularly remove product residues and splitters from the entire system area.
- » Check that the screw connections on all load-bearing and moving parts are tightened correctly
- » Check correct function of bearings and links.
- » Check the function of the safety devices.
- » Wear appropriate personal protective gear in the system area.

Prerequisite:

- System is switched off and safeguarded against being restarted.

## 3.2 Assembly the slide rails and slide profiles on the modular belt conveyor

Observe the following during assembly:

- Install the slide rails and slide profiles in a number of continuous lengths where possible.
- In areas with high loads, the slide rails and slide profiles must be separated to enable expansion. Separation is required at bending wheels, deflection units and drive units.
- Never connect slide rails and slide profiles in horizontal or vertical sliding bends.
- Avoid slide rail and slide profile connections at the connection points of the holding and chassis profiles.

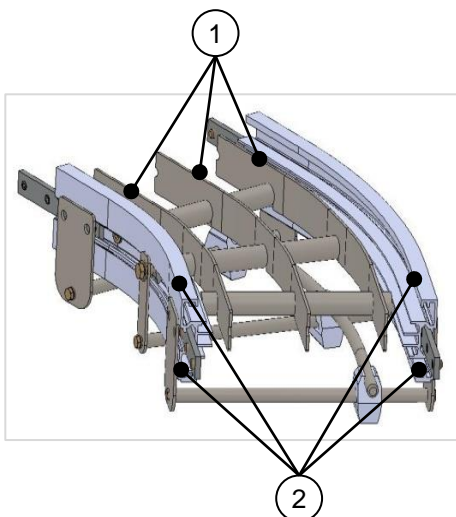

1. Clip the slide rails (2) onto the chassis profile.
2. Press the slide profiles onto the holding profile (1).

Fig. 2: Assembly the slide rails and slide profiles on the modular belt conveyor

### 3.2.1 Assembly the slide rails on the modular belt conveyor

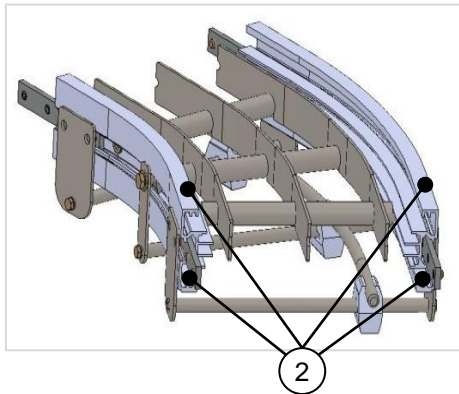

1. Clip the slide rails (2) onto the chassis profile.



2. Check the slide rail for damage.

Only use undamaged slide rails.

3. Chamfer the slide rail at the start (viewed in running direction).

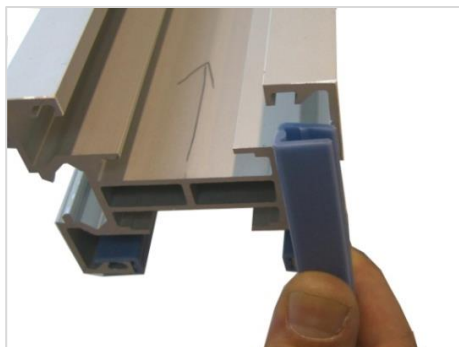

4. Clip slide rail onto the chassis profile with the nose on the underside (see Figure).

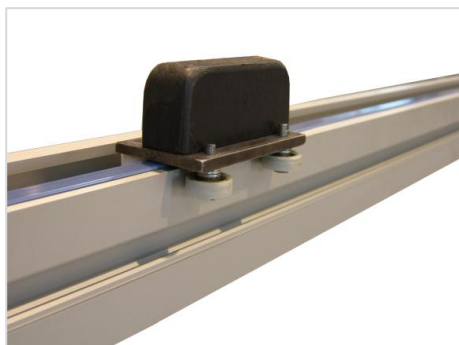

5. Clip slide rail onto the chassis profile in the running direction with the assembly tool.

Avoid the development of "waves" in the slide rail by clipping it on completely (audibly).

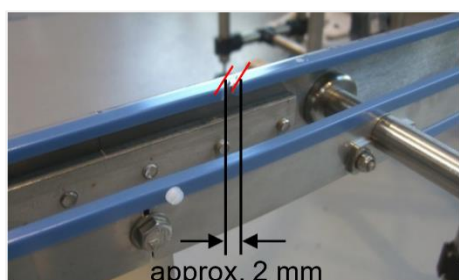

6. Mount the slide profile seams with a gap of approx. 2 mm and offset.

7. Cut the slide profiles at an angle in the running direction.

8. Gently deburr the butt ends.

9. Always mount the slide profiles over the seams of the chassis profile.



10. Cut the slide profile straight at the end of the chassis profile (viewed in running direction) and clip it on flush.

11. Gently deburr the butt ends.

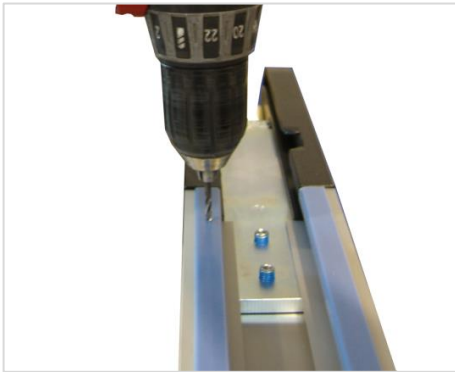

12. Each slide rail piece must be fixed at the start (viewed in the running direction).

13. Using the drill (drill bit  $\varnothing$  3.4 mm), drill a hole in the slide rail and chassis.

Do not drill through slide rail. The underside of the slide rail must not be drilled or protruding.

14. After drilling, deburr and remove all chips.

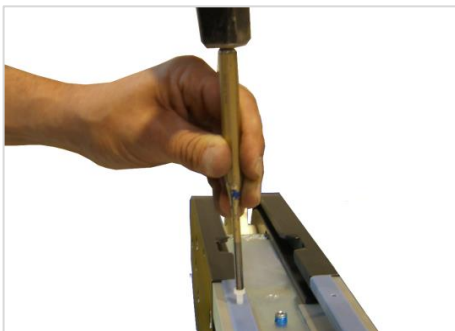

15. Carefully knock in M4 x 8 plastic screw.



16. Cut the screw head carefully and flush.

17. Rework possible supernatants with the file.

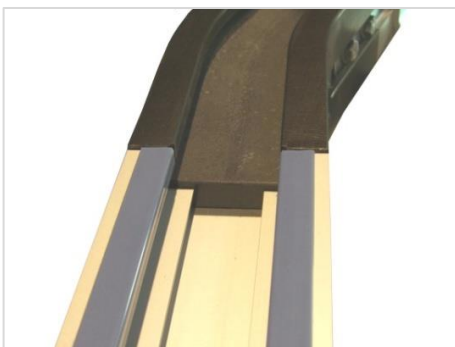

18. Before intermediate elements or subsequent elements, mount the slide rail flush with the end of the chassis profile (viewed in running direction)

19. At the end of the conveyor, mount the slide rail flush with the drive station.

Fig. 3: Assembly the slide rails on the modular belt conveyor

### 3.2.2 Assembly the slide profiles on the modular belt conveyor

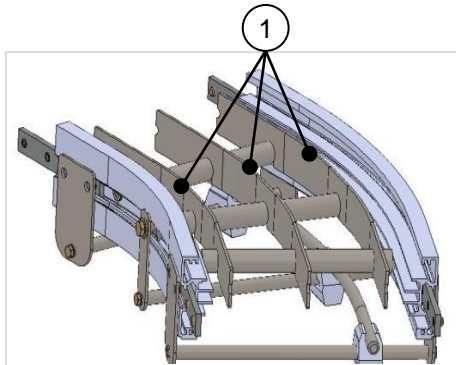

1. Press the slide profiles onto the holding profile(1).



2. Check the slide profiles for damage.  
Only use undamaged slide profiles.

3. Chamfer the slide profiles at the start (viewed in running direction).



4. Press the slide profiles in the running direction onto the top of the holding profile.

Avoid the development of “waves” in the slide profiles by clipping it on completely.

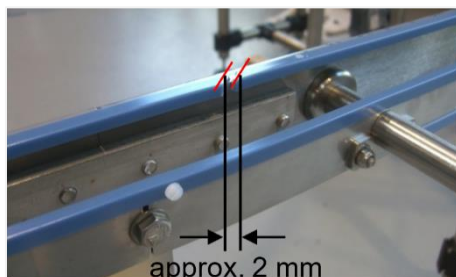

5. Mount the slide profile seams with a gap of approx. 2 mm and offset.

6. Cut the slide profiles at an angle in the running direction.

7. Gently deburr the butt ends.

8. Always mount the slide profiles over the seams of the holding profile.



9. Cut the slide profile straight at the end of the holding profile (viewed in running direction) and press it on flush.

10. Gently deburr the butt ends.

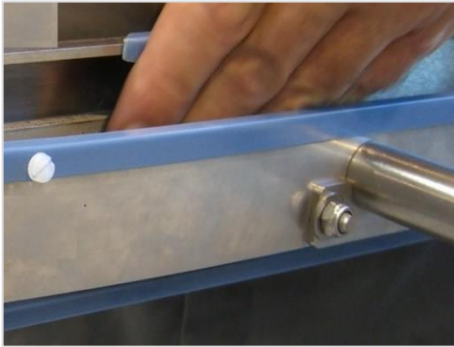

11. Each slide profile piece must be fixed at the beginning (viewed in running direction).
12. Using the drill (drill bit  $\varnothing$  3.4 mm), drill a hole in the slide profile and holding profile.

Secure the profile with a support against bending!

13. After drilling, deburr and remove all chips.
14. Carefully knock in M4 x 8 plastic screw.

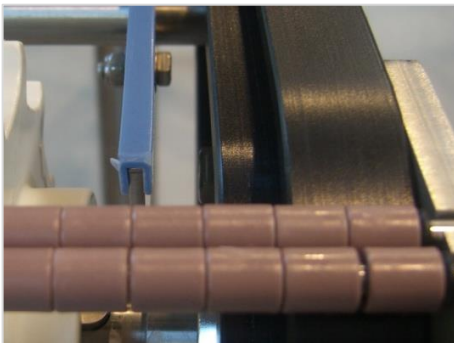

15. Before intermediate elements or subsequent elements, mount the slide profile flush with the end of the holding profile (viewed in running direction)
16. At the end of the conveyor, mount the slide profile flush with the drive.

Fig. 4: Assembly the slide profiles on the modular belt conveyor

### 3.3 Assembling the modular chain belt

Observe the following during assembly:

- Select the chain length so that the contraction of the chain ends is done with little effort.
- ! With a tight chain, rattling will be heard at the drive station.



1. Check the run using a short piece of the chain.
2. Remove any clamping points and rework seams if necessary.

Observe the running direction of the chain.

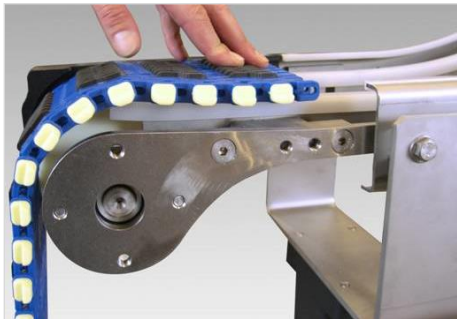

3. Feed the chain into the deflection in the running direction and slide on/pull through until the chain has been completely pulled through the conveyor.

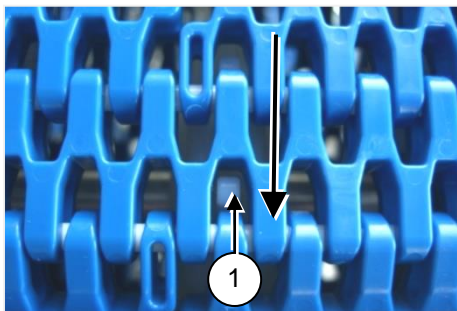

4. Chain insertion at the drive unit:
  - Tooth engaging (1) on the back of the chain link (as shown in the figure)!



5. Chain insertion in curved area:
  - Outside (1) of the curve
  - Inside (2) of the curve

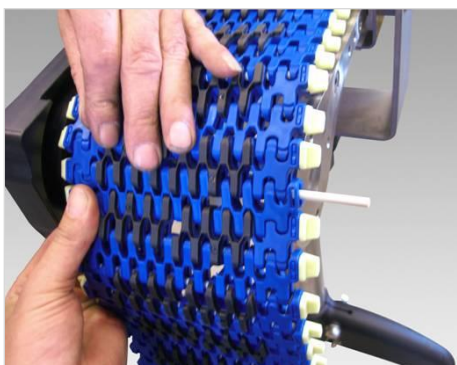

6. At the assembly opening fit the connecting rod and close the chain with this.
7. Select the chain length so that the contraction of the chain ends is done with little effort.
8. Add a chain link if necessary.

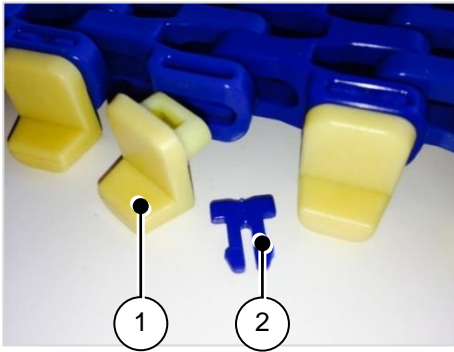

Fig. 5: Assembling the modular chain belt

9. Insert fastening clip as follows:
  - a) Insert the yellow tab (1) with the foot pointing downwards into the lateral chain opening.
  - b) Subsequently press the blue closure PIN (2) from above into the opening over the tab until the PIN latches into place.



## 4 Cleaning

This chapter provides information on the execution of the operating mode Cleaning:

- Personnel and Protective equipment (Page 17)
- Selection of the cleaning agent (Page 17)
- Preparation (Page 18)
- Execution (Page 18)

### ATTENTION

#### Warning of material damage due to improper cleaning!

Improper cleaning leads to damage to the system or its surroundings.

- » Cleaning the system according to the instructions in this installation guide.
- » Do not use steam jet or high-pressure cleaning devices for cleaning surfaces.
- » Do not use compressed air for cleaning and drying surfaces.

### 4.1 Personnel and Protective equipment

Personnel and Protective equipment

Specification	Designation
Personnel	Operating personnel
Personal protective equipment	Protective equipment against the cleaning agents used according to the instructions of the manufacturer of the cleaning agents

### 4.2 Selection of the cleaning agent

The cleaning agents used are specified by the local hygiene officer.

Observe the cleaning agent manufacturer's instructions.

Furthermore, observe the following:

Find application:

- Solutions with a pH value between 4.5 and 9
- Water with a pressure of 10 to 20 bar
- Water with temperatures from 52°C to 54°C

Find no application:

- Cleaning products containing chlorine, ammoniac, phosphoric acid or their compounds
- Abrasive cleaning products
- Solutions with a pH value below 4.5 or above 9
- Water with a pressure above 20 bar
- Water with temperatures above 54°C

## 4.3 Preparation

Carry out the following work steps:

1. Switch off the conveyor system.
  - ▼ No voltage is present at the conveyor system.
2. Close the pneumatic supply at the main valve and secure it with a personal padlock.
3. Secure the main switch on the control cabinet with a personal padlock.

The conveyor system is prepared for cleaning.

✓ **Ready.**

## 4.4 Execution

Prerequisite:

- Conveyor system is switched off and secured against being switched on again
- Conveyor system is prepared for cleaning



### Info

---

The most efficient way to clean a conveyor is from top to bottom and from the centre to the outside.

Perform the following steps:

1. Remove residue of conveyance goods.
2. Dry cleaning:  
Remove coarse dirt without damaging the surface of the conveyor belt as well as gear wheels, shafts and other parts (e.g. guide rails, slide rails etc.).
3. Rinse off:  
Rinse conveyor belt with warm water (52 °C to 54 °C) and a pressure of 10 to 20 bar.
4. Application of the cleaning agent:  
Apply suitable cleaning agent to the conveyor at a pressure of 10 bar.  
Allow cleaning agent to act for 10 to 15 minutes.
  - ! Do not allow cleaning agent to dry in (danger of chemical compounds).
5. Rinse and inspect:  
Thoroughly rinse the conveyor belt with water at a pressure of 2.8 to 4.1 bar and a temperature of 52 °C to 54 °C.
  - ! Inspect conveyor (sensory analysis: See, smell and feel) and ensure that dirt, cleaning agent, water and other residues have been rinsed away.
  - ! Take care when using strong cleaning agents.

6. pH value test:  
Inspect the conveyor again. Ensure that all residues of the chemical cleaning agent have been removed from the conveyor belt.  
  
To do this, check with a pH strip (litmus paper) whether all residues of the alkaline solution have been removed.  
  
Run the conveyor belt slowly to dry the conveyor belt. Meanwhile, remove accumulated water from the floor.
  7. Check and release for disinfection:  
Check conveyor belt again by sensory analysis and disinfect.  
  
! Use an adenosine triphosphate (ATP) test to confirm/exclude the presence of bacteria.  
! If the ATP test is positive, clean the checked area again.
  8. Disinfection:  
Run the conveyor belt again at a slow speed. Use disinfectant as specified by the manufacturer.  
  
! Take care not to apply too much disinfectant so that the conveyor does not need to be rinsed.  
! Remove excess disinfectant via the drain.
- ✓ **Ready.**

Contact euroflex GmbH for instructions on cleaning any further contaminants.

## 5 Maintenance

This chapter provides information on the maintenance work to be carried out:

- Lubrication (Page 20)
- Maintenance plan (Page 21)
- Maintenance log (Page 23)
- Repair (Page 23)

### 5.1 Lubrication

Incorrect or negligent use of hazardous substances may lead to serious environmental pollution.

Observe the following:

- Apply lubricant evenly and sparingly at the specified points.
- Carefully remove any escaping, used or excess lubricant.
- Deal with solvents and cleaning agents in accordance with the manufacturer's safety data sheet.
- Dispose of all hazardous substances in accordance with the regional guidelines and commission a specialist company if required.

Malfunctions and excessive levels of wear on individual components are likely to result from the use of operating substances that cause significant pollution and/or that fail to comply with the stipulated specification. Warranty claims that can be traced back to this content shall be rejected.

Observe the following:

- Use operating substances with the specified purity class.
- Check the state of the operating substance at regular intervals.

#### Lubrication schedule

No.	Designation			
	Name	Note	Interval [Bh]	Lubricant
1	Roller chain (Drive)	Spray!	250 also after each cleaning	Chain Lubricant Spray NSF H1
2	Drive station, Deflection, Sliding bend, Bending wheel	Spray!	250 also after each cleaning	Silicone spray NSF H1
3	Gear motor (Drive motor)	Details on lubrication and maintenance see manufacturer of the gearmotor		

## 5.2 Maintenance plan

Regular maintenance and care are required for the operational safety and fault-free operation of the system. The specifications in the maintenance plan are guide values and must be adjusted by the owner depending on the operating conditions.

### ATTENTION

#### Warning of material damage due to non-original spare parts!

Use of non-original spare parts can lead to defects in the conveyance goods, operational malfunctions, loss of safety functions and damage to or destruction of components.

- » Only replace components with original spare parts from euromflex GmbH.

#### General

Assembly and maintenance work		Interval [Bh]	Personnel
Inspect the conveyor system for visible damage, noise and vibration		8 (per shift)	Operating personnel
Safety and protective devices	Check for completeness and function	8 (per shift)	Operating personnel
	Replace defective equipment	Replace if required	Maintenance personnel
Operating and display elements (buttons, switches, indicator lamps, manometers)	Check functionality	24 (daily)	Operating personnel
	Replace defective components	Replace if required	Maintenance personnel
Signage	Check legibility and completeness	24 (daily)	Operating personnel
	Clean or replace, if required	Replace if required	
Check fixing elements, retighten if required		1.000 (quarterly)	Maintenance personnel
Check the supply lines and connections for leakage		after the first 20 24 (daily)	Maintenance personnel
Electrical connections	Check for damage and firm seating	24 (daily)	Electricians
	Replace defective connections	Replace if required	
Adhere to lubrication schedule		"Lubrication schedule" (Page 20)	Maintenance personnel
Clean conveyor system		24 (daily)	Operating personnel

Conveyor system

Assembly and maintenance work		Interval [Bh]			Personnel
Remove foreign bodies		8 (per shift)			Operating personnel
Clean conveyor system surface		8 (per shift)			Operating personnel
Check gear unit for leakage		8 (per shift)			Maintenance personnel
Inspect surface for damage		170			Maintenance personnel
Conveyor chain	check for damage and elongation	50	250	500	Maintenance personnel
		thereafter every 500			
	replace	4,000			
Slide rails/ Slide profiles	check for damage and wear	50	250	500	Maintenance personnel
		thereafter every 500			
	replace	4,000			
	check all connections				
Check bending wheel for damage and wear		500			Maintenance personnel
Check sliding bend for damage and wear		500			Maintenance personnel
Check roller transition/end module for damage and wear		500			Maintenance personnel
Flange bearing: Check eccentric ring for secure seating		170			Maintenance personnel
Check motor plate for secure seating		500			Maintenance personnel
Check bearing and links for correct function		1,000 (quarterly)			Maintenance personnel
Check toothed wheel for damage and wear		50	250	500	Maintenance personnel
		thereafter every 500			

Drive/Deflection unit

Assembly and maintenance work		Interval [Bh]			Personnel
Guides of the conveyor chain (KU side parts)	check for damage and wear	1,000 (quarterly)			Maintenance personnel
	replace	7,000			
Sprocket wheel/ Deflection roller	check for damage and wear	1,000 (quarterly)			Maintenance personnel
	replace	7,000			
Ball bearing	replace	7,000			Maintenance personnel
Sheet metal flange bearing	replace	7,000			Maintenance personnel
Roller chain at the drive station	check for damage and elongation	50	250	500	Maintenance personnel
		thereafter every 500			
Sprocket wheel on roller chain	check for damage and wear	1,000 (quarterly)			Maintenance personnel
	replace	7,000			

**Electrical system**

Assembly and maintenance work	Interval [Bh]	Personnel
Check electrical wiring for visible damage	40	Electricians
Electrical connections and distributors: Check terminal boxes for damage	170	Electricians

### 5.3 Maintenance log

The required maintenance intervals are dependent on the intensity of use of the system at the owner's deployment site and the consequent signs of wear. In order to be able to adjust the maintenance intervals of these terms of use, the general condition of the system as a whole as well as the assemblies and components must be logged in detail during the regular and (if required) unscheduled maintenance work.

Observe the following when creating maintenance logs:

- Produce a maintenance log for each maintenance task and log all performed maintenance work.
- Store the maintenance logs.

### 5.4 Repair

Incorrect repair work impairs the operational safety. This can cause accidents and seriously injure people as a result.

Observe the following:

- Repair work may only be carried out by the manufacturer or authorized specialist personnel.
- Switch off the system and secure it against being switched back on before all repair work.
- Switch off the compressed air system and secure it against being switched back on. Depressurize the compressed air-conveying components. Check if the pneumatic system has been relieved of pressure.
- Work on the electrical system may only be carried out by trained electricians.
- For all work on the electrical system, switch off the voltage supply and secure it against being switched back on again by accident.
- Only use original spare parts.

In case of repairs at the conveyor system, the customer service will help (see page 4: Customer service).

Spare parts can be ordered directly from the manufacturer (see page 8: Spare parts and their purchase).

**Personnel**

Specification	Designation
Personnel	Maintenance personnel

### 5.4.1 Conveyor chain: Repair or adjust the chain tension



#### **WARNING**

##### **Danger to life due to moving machine parts!**

Danger of injury and pulling in due to too long chain sag! Risk of crushing and cutting!

Moving machine parts can cause serious personal injury or death.

- » Prior to starting, ensure that no persons are present in the danger zone.
  - » Do not reach into moving machine parts during operation.
  - » Maintain a safe distance from moving machine parts during operation.
  - » Only carry out repairs, maintenance, cleaning and disassembly work when de-energised.
- 

If one or more chain links are damaged, they must be replaced.

If an uneven running or ambient noise occurs, it is necessary to shorten the chain belt.

Select the chain length so that the contraction of the chain ends is done with little effort.



### 5.4.1.1 Adjust modular belt chain

Data	Designation or value
Personnel	Maintenance personnel
Personal protective equipment	Protective work clothing Protective gloves Safety shoes
Interval	in each case after 50 OH, 250 OH, 500 OH, then check every 500 OH Replace after 4,000 OH
Tools, aids	Allen key Screwdriver Needle nose plier

Prerequisite:

- System is switched off and safeguarded against being restarted.

Perform the following steps:

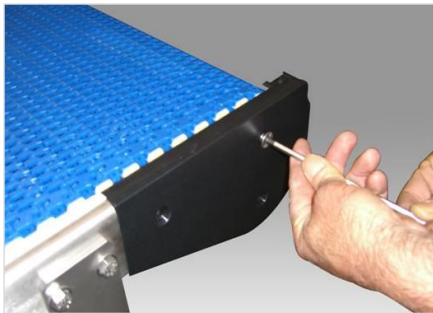

1. Loosen screws at the side parts of the deflection.

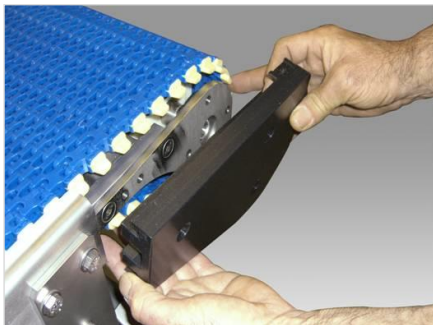

2. Remove side parts.

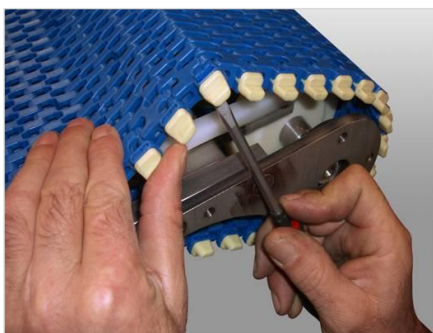

3. Lift the chain upwards.

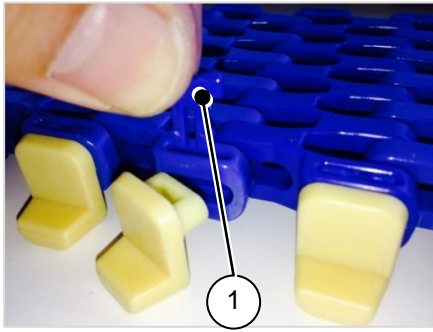

Remove fastening clip as follows:

4. Press the blue locking pin (1) upwards and remove.



5. Pull the yellow tab out.

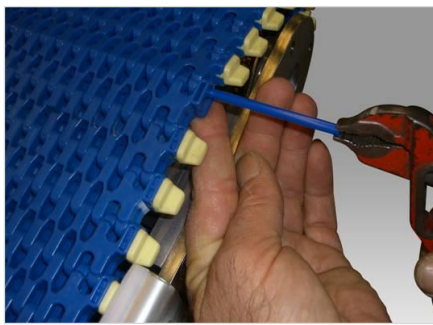

6. Pull out connecting rod.

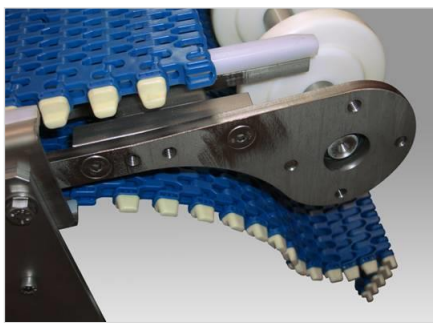

7. Draw out opened chain.
8. Insert new chain or replace damaged chain links.
9. Reinsert the connecting rod.

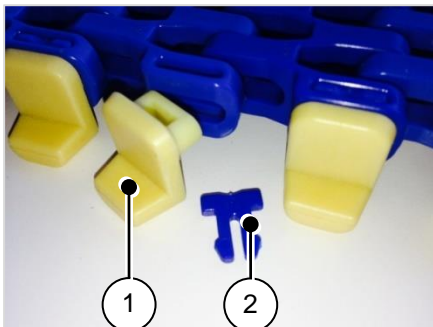

Insert fastening clip as follows:

10. Insert the yellow tab (1) with the foot pointing downwards into the lateral chain opening.
11. Subsequently press the blue closure PIN (2) from above into the opening over the tab until the PIN latches into place.
12. Reattach and fasten the side parts.

✓ **Ready.**

Fig. 6: Adjust modular belt chain

## **6 Table of figures**

---

Fig. 1: Overview of MB-flex S aluminium (example).....	9
Fig. 2: Assembly the slide rails and slide profiles on the modular belt conveyor.....	10
Fig. 3: Assembly the slide rails on the modular belt conveyor.....	12
Fig. 4: Assembly the slide profiles on the modular belt conveyor.....	14
Fig. 5: Assembling the modular chain belt.....	16
Fig. 6: Adjust modular belt chainAdjust modular belt chain.....	26